

REV	DESCRIPTION	DATE	APPROVAL
REVISIONS			
A	DRAWING RELEASE	1-31-03	DM
B	GUIDE ATTACH AT JOE	11-15-03	DM
C	ADD GUIDE OPTION 3	4-13-04	DM
D	RETEST FOR FLORIDA	9-26-05	DM
E	REMOVED DIMENSIONS, DATES	6-17-09	CS
F	ADDED 1" BRACKET OPTION	01-20-12	CS
F	ADDED CHARTED PSF VALUES	11-07-12	CS

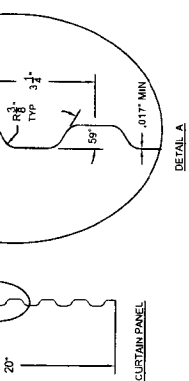

**HEADROOM REQUIRED**

DRINKING FOUNTAIN HEIGHT	VERTICAL HEADROOM	HORIZONTAL HEADROOM	CURTAIN PANEL		
			OVER	UNDER	THRU
17"	17"	19"	21"	27"	25"
19"	19"	21"	23"	29"	27"
21"	21"	23"	25"	31"	29"
23"	23"	25"	27"	33"	31"

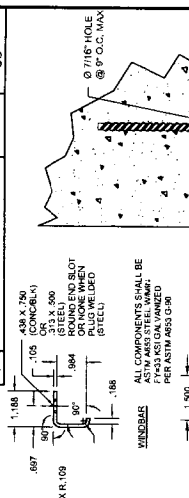
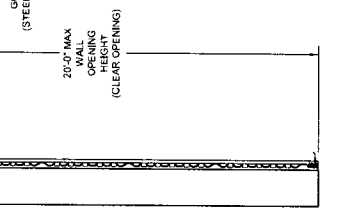
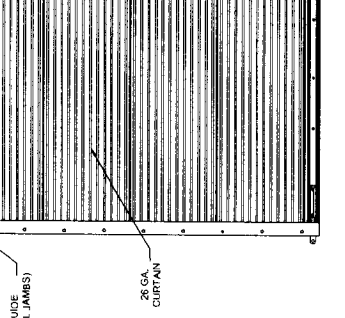
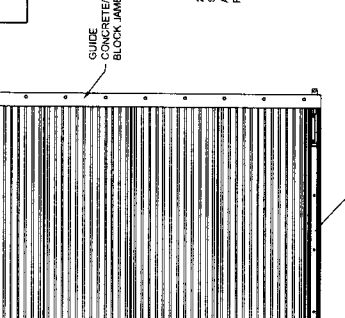
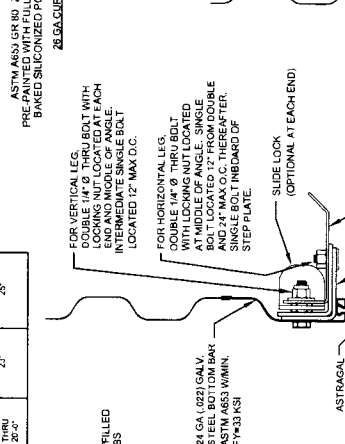
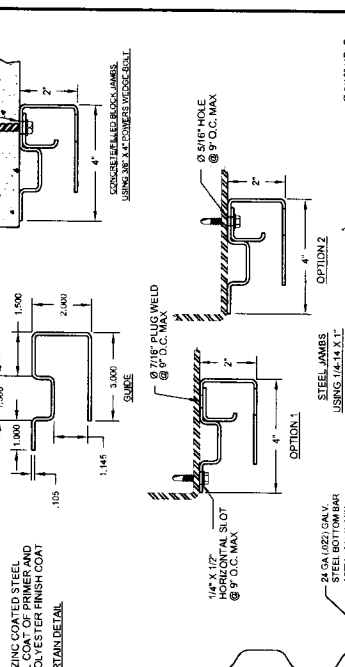

WINDLOCK MATERIAL: G30 GALV. ASTM A653 STRUCTURAL STEEL GRADE 50, CLASS 1 MIN Fy=50 KSI

**JANUS INTERNATIONAL CORPORATION**  
 134 JANUS INTERNATIONAL BLVD TEMPLE, GA 30179  
 770-562-2650/Fax 770-562-2264  
 © 2012, Janus International Corporation All Rights Reserved

DATE	APPROVAL
11-07-12	CURT SCHROEDER
11-07-12	CURT SCHROEDER
11-07-12	CURT SCHROEDER

CERTIFIED WIND LOAD RATED 26  
 GA. SERIES 3100 DOOR ASSEMBLY  
 MAX. SIZE: 20'-0" X 20'-0"

REV. **F**

FORMING NUMBER: **B**  
 SIZE: **T1005**  
 NONE OF: 2

THESE CONFIDENTIAL DOCUMENTS SUBMITTED BY JANUS CONTAIN INFORMATION OF A PROPRIETARY NATURE AND MAY NOT BE REPRODUCED OR USED TO MANUFACTURE ANYTHING IN PART OR WHOLE FOR ANY PURPOSE OTHER THAN THAT WHICH IS NECESSARY FOR PREPARATION OF BIDS OF ENGINEERING WITHOUT EXPRESS PERMISSION OF JANUS WHICH MAY RECALL DOCUMENTS AT ANY TIME.

ALL DIMENSIONS UNLESS SPECIFIED ARE IN INCHES. TOLERANCES LISTED BELOW:

DESCRIPTION	TOLERANCES
HOLE DIAMETERS	+0.004 -0.003
UNDER 0.251	+0.006 -0.003
0.251 - 0.500	+0.008 -0.003
OVER 0.500	+0.008 -0.003

SEE SHEET 2 FOR NOTES

STATE OF FLORIDA PROFESSIONAL ENGINEER  
 JOSEPH W. DIACON JR.  
 LICENSE No. 7768  
 12/6/12

REV	DESCRIPTION	DATE	APPROVAL
A	DRAWING RELEASE	1-31-03	DM
B	GUIDE ATTACH AT TOE	11-13-03	DM
C	ADD GUIDE OPTION 3	4-13-04	DM
D	RETEST FOR FLORIDA	9-26-05	DM
E	REMOVED STD. DRGS. DATES	9-26-05	CS
F	ADDED "T" BRACKET OPTION	01-20-12	CS
F	ADDED CHARTED PSF VALUES	11-07-12	CS

ALLOWABLE TRANSVERSE DESIGN WIND LOADS (PSF)			
MAX DOOR WIDTH	MAX DOOR HEIGHT	DESIGN LOAD POSITIVE (PSF)	DESIGN LOAD NEGATIVE (PSF)
15'-0"	20'-0"	38.9	42.2
16'-0"	20'-0"	35.0	38.0
17'-0"	20'-0"	31.7	34.5
18'-0"	20'-0"	29.0	31.5
19'-0"	20'-0"	26.6	28.9
20'-0"	20'-0"	24.5	26.7

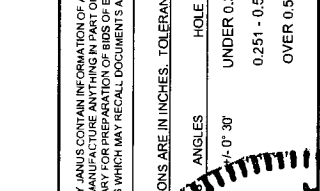
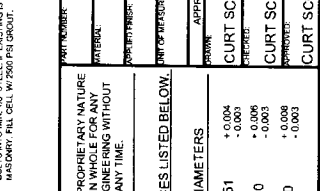
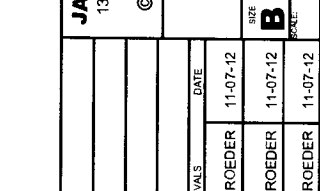
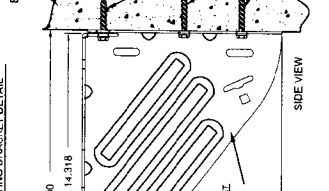
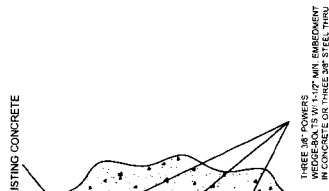
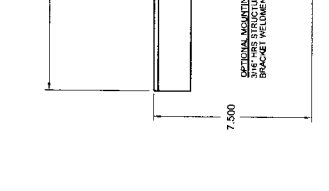
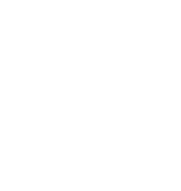
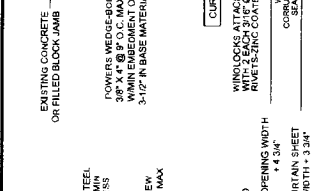
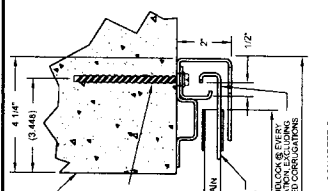

**SUPERIMPOSED LOAD DIAGRAM**

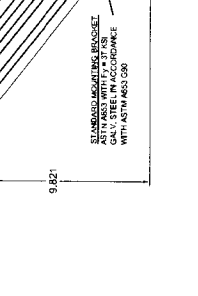

DESIGN LOAD = 35.0 PSF

- WIND LOADS FOR BUILDING OPENINGS SHALL BE DETERMINED BY A PROFESSIONAL ENGINEER USING MEETS OR EXCEEDS THE DESIGN LOAD FOR THE BUILDING OPENING.
- WIND LOADS FOR BUILDING OPENINGS SHALL BE DETERMINED BY A PROFESSIONAL ENGINEER USING MEETS OR EXCEEDS THE DESIGN LOAD FOR THE BUILDING OPENING.
- WIND LOADS FOR BUILDING OPENINGS SHALL BE DETERMINED BY A PROFESSIONAL ENGINEER USING MEETS OR EXCEEDS THE DESIGN LOAD FOR THE BUILDING OPENING.
- WIND LOADS FOR BUILDING OPENINGS SHALL BE DETERMINED BY A PROFESSIONAL ENGINEER USING MEETS OR EXCEEDS THE DESIGN LOAD FOR THE BUILDING OPENING.
- WIND LOADS FOR BUILDING OPENINGS SHALL BE DETERMINED BY A PROFESSIONAL ENGINEER USING MEETS OR EXCEEDS THE DESIGN LOAD FOR THE BUILDING OPENING.
- WIND LOADS FOR BUILDING OPENINGS SHALL BE DETERMINED BY A PROFESSIONAL ENGINEER USING MEETS OR EXCEEDS THE DESIGN LOAD FOR THE BUILDING OPENING.
- WIND LOADS FOR BUILDING OPENINGS SHALL BE DETERMINED BY A PROFESSIONAL ENGINEER USING MEETS OR EXCEEDS THE DESIGN LOAD FOR THE BUILDING OPENING.
- WIND LOADS FOR BUILDING OPENINGS SHALL BE DETERMINED BY A PROFESSIONAL ENGINEER USING MEETS OR EXCEEDS THE DESIGN LOAD FOR THE BUILDING OPENING.
- WIND LOADS FOR BUILDING OPENINGS SHALL BE DETERMINED BY A PROFESSIONAL ENGINEER USING MEETS OR EXCEEDS THE DESIGN LOAD FOR THE BUILDING OPENING.
- WIND LOADS FOR BUILDING OPENINGS SHALL BE DETERMINED BY A PROFESSIONAL ENGINEER USING MEETS OR EXCEEDS THE DESIGN LOAD FOR THE BUILDING OPENING.
- WIND LOADS FOR BUILDING OPENINGS SHALL BE DETERMINED BY A PROFESSIONAL ENGINEER USING MEETS OR EXCEEDS THE DESIGN LOAD FOR THE BUILDING OPENING.
- WIND LOADS FOR BUILDING OPENINGS SHALL BE DETERMINED BY A PROFESSIONAL ENGINEER USING MEETS OR EXCEEDS THE DESIGN LOAD FOR THE BUILDING OPENING.
- WIND LOADS FOR BUILDING OPENINGS SHALL BE DETERMINED BY A PROFESSIONAL ENGINEER USING MEETS OR EXCEEDS THE DESIGN LOAD FOR THE BUILDING OPENING.
- WIND LOADS FOR BUILDING OPENINGS SHALL BE DETERMINED BY A PROFESSIONAL ENGINEER USING MEETS OR EXCEEDS THE DESIGN LOAD FOR THE BUILDING OPENING.
- WIND LOADS FOR BUILDING OPENINGS SHALL BE DETERMINED BY A PROFESSIONAL ENGINEER USING MEETS OR EXCEEDS THE DESIGN LOAD FOR THE BUILDING OPENING.

**JANUS INTERNATIONAL CORPORATION**  
 134 JANUS INTERNATIONAL BLVD TEMPLE, GA 30179  
 770-562-2850/Fax 770-562-2264  
 © 2012 Janus International Corporation All Rights Reserved

CERTIFIED WIND LOAD RATED 26  
 GA. SERIES 3100 DOOR ASSEMBLY  
 MAX. SIZE: 20'-0" X 20'-0"

REV. F  
 DRAWING NUMBER: T1005  
 NONE SHEET: 2 OF: 2

DATE	APPROVALS
11-07-12	CURT SCHROEDER
11-07-12	CURT SCHROEDER
11-07-12	CURT SCHROEDER

THESE CONFIDENTIAL DOCUMENTS SUBMITTED BY JANUS CONTAIN INFORMATION OF A PROPRIETARY NATURE AND MAY NOT BE REPRODUCED OR USED TO MANUFACTURE ANYTHING IN PART OR IN WHOLE FOR ANY PURPOSE OTHER THAN THAT FOR WHICH IT WAS PREPARED. IT IS THE POLICY OF JANUS WHICH MAY RECALL DOCUMENTS AT ANY TIME.

UNLESS OTHERWISE SPECIFIED, DIMENSIONS ARE IN INCHES. TOLERANCES LISTED BELOW.

DESIGNATION	ANGLES	HOLE DIAMETERS
±0.004	UNDER 0.251	+0.004
±0.003	0.251 - 0.500	+0.003
±0.003	OVER 0.500	+0.003
±0.003		+0.003

STATE OF FLORIDA  
 PROFESSIONAL ENGINEER  
 No. 7768  
 JOSEPH M. DAVIDSON

12/6/12